

NO GREASE RUDDER BEARING SYSTEMS



THORNDON

ZERO POLLUTION | HIGH PERFORMANCE | BEARING SYSTEMS

NEVER GREASE YOUR RUDDER SYSTEM AGAIN

USE THORDON SXL RUDDER BEARINGS AND THORPLAS TILLER ARM BEARINGS

With over 40,000 vessel years of experience over the past 30 years, Thordon knows rudder bearings.

- Thordon SXL bearings are recommended in the lower and upper rudder bearing positions and pintles, as well as the thrust washer position.
- ThorPlas bearings are recommended for the more highly loaded bushings in the tiller arm and "jockey-bar" linkages.

Both products operate grease free saving you time, money and the risk of pollution.

Benefits

- Greasing is eliminated including the labor, cost and potential source of pollution
- SXL's elastomeric nature resists abrasive wear and will not pound out of shape
- Internal lubricants formulated into SXL and ThorPlas reduce friction, resulting in smooth operation without lubrication
- Thordon bearings operate above and below the water line
- Both SXL and ThorPlas machine easily, and dust-free, to suit required dimensions
- Installation is quick and easy using freeze fit or press fit techniques
- Improved safety for crew not having to grease rudder system

SXL

Thordon SXL is an elastomer that has been used as a rudder bearing on over 4000 ships. When operating in water with abrasives present, SXL tends to deflect and then reject abrasive particles allowing them to pass through the bearing without being embedded or gouging; thus bearing wear is minimized. Grease or other lubricants are not required. Thordon SXL is ideal in the lower and upper bearing positions and pintles, as well as the thrust washer position.

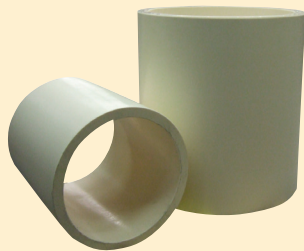

ThorPlas

ThorPlas is an engineered thermoplastic that ensures smooth and maintenance-free operation in steering gear equipment. It is a self-lubricating, homogenous polymer that does not require grease or other lubricants. ThorPlas works well in the highly loaded bushings in the tiller arm and "jockeybar" linkages. ThorPlas fits into virtually all applications where greased bronze is currently used.



The ThorPlas Split Spherical Bearing (SSB) solves the problem of less than desirable alignment tolerances in the hydraulic steering system. It is easy to change, operates without grease and reduces piston and cylinder damage.

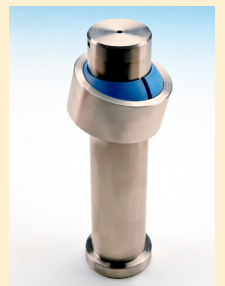

TYPICAL WORKBOAT RUDDER ARRANGEMENT

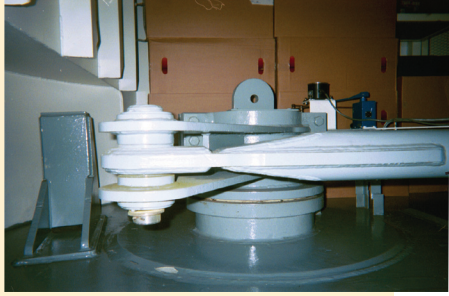

SXL for Thrust Washers

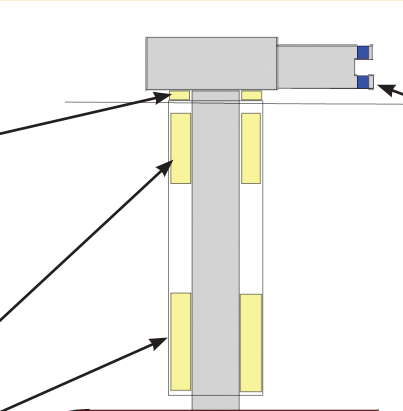

SXL for Both Upper and Lower Bearing Positions as well as Pintles

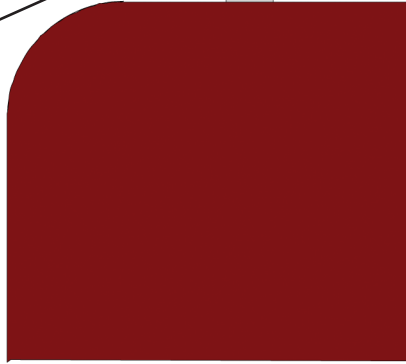

ThorPlas for Tiller Arms and Jockey Bars

GREASE-FREE RUDDER BEARING SYSTEMS

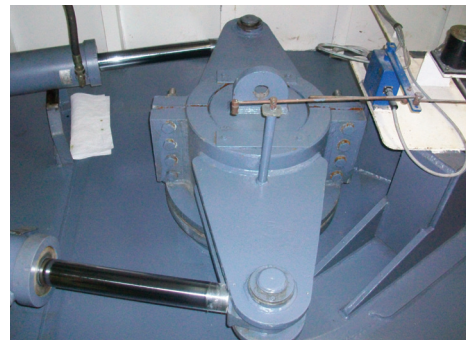
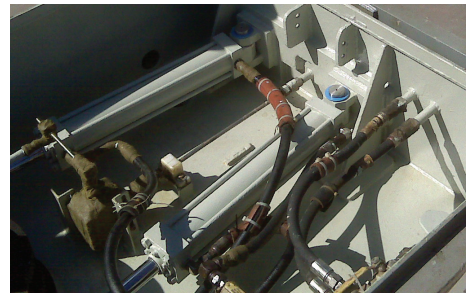

Thordon grease-free operation saves time and money and the risk of pollution.

CUSTOMER FOCUSED TO QUICKLY MEET YOUR NEEDS

Quick and Responsive Service

It takes quality products to be globally successful in the water lubricated bearing industry. It also takes great service to keep customers coming back.

Thordon Bearings Inc. is geared to respond quickly to supply high performance bearing solutions. Thordon bearings arrive quickly, fit right and last!

Extensive Distribution Network

Thordon Bearings has an extensive distribution network to supply our global customers. More than 70 distributors in 100 countries carry extensive inventories of Thordon's common bearing sizes which are backed by large regional and head office inventories. Non-standard requests are met with responsive design, quick machining and speedy delivery.

Application Engineering

Thordon engineers work closely with customers to provide innovative bearing system designs and solutions. We offer in-house design, CAD and the proprietary Thordon Bearing Sizing Calculation Program to help correctly size our bearings.

Our decades of experience mean that we offer the right technical support during design, machining, installation and operation.

Manufacturing Quality

Thordon Bearings Inc. is a family-owned company that operates a state-of-the-art polymer processing plant and new product development facilities in Burlington, Ontario, Canada.

We manufacture to ISO 9001:2008 Quality System requirements. Contact us for references of our installations.

High Performance Bearings; Industry-Leading Service

Thordon Bearings is an industry leader in the design, manufacture, supply and installation of high performance, pollution-free, bearings systems.

Your Authorized Thordon Distributor

THORDON

Thordon Bearings Inc.

3225 Mainway, Burlington, Ontario, L7M 1A6 Canada

Tel: +1.905.335.1440 Fax: +1.905.335.4033 Email: info@thordonbearings.com Website: www.ThordonBearings.com